

FRONTVY

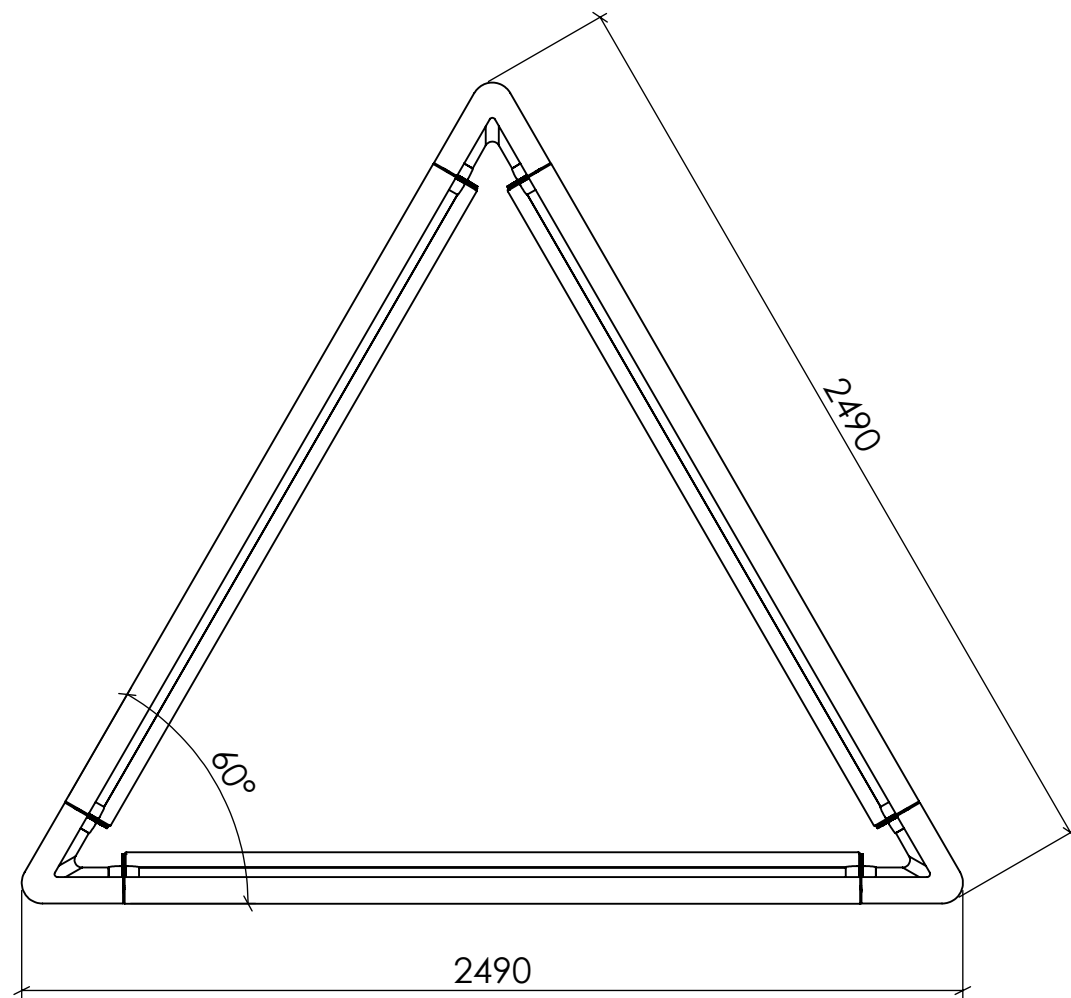

TOPPVY

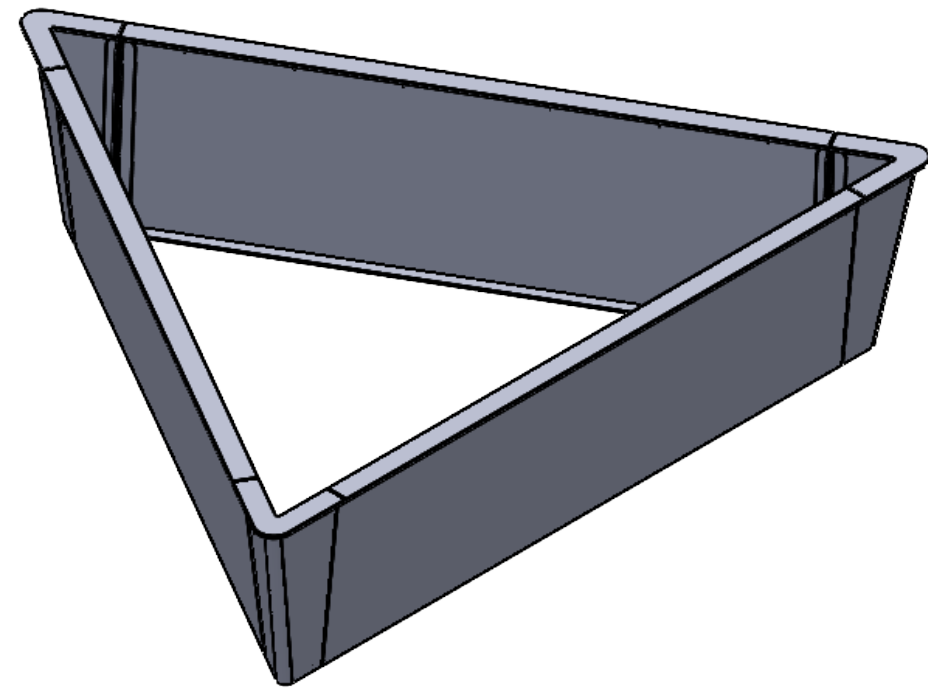

Svetsklass C	Förbehandlingsgrad P2	Toleransklass KLASS 1	Utförandeklass -	Certifiering SS-EN 1090-1	Övrigt	
Beräkningsunderlag -	Ritad Av DANIEL	Skapad Datum 2020-06-29	Godkänd Av PETER	Material -	Antal	Order- /Projektnummer
Ägare  BLIDSBERGS MEKANISKA			Titel / Benämning HAGA Plantering - 60° 2490			
Adress: Ulricehamnsvägen 27, 52376 Blidsberg Telefonnummer: 0321-31660 E-post: info@blidsbergs.se, www.blidsbergs.se			Artikel- / Ritningsnummer VFZ 450303 / VFZ+L 450306 / Corten 450309	Rev	Blad 1 (1)	