

FRONTVY

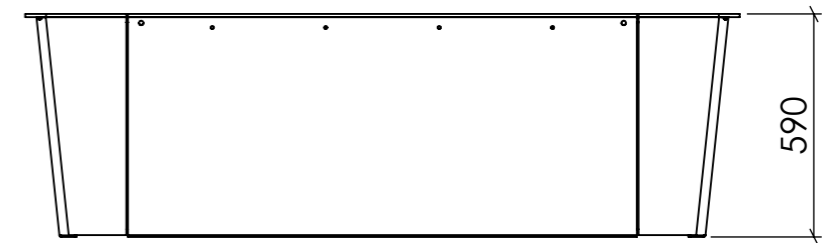

SIDOVY

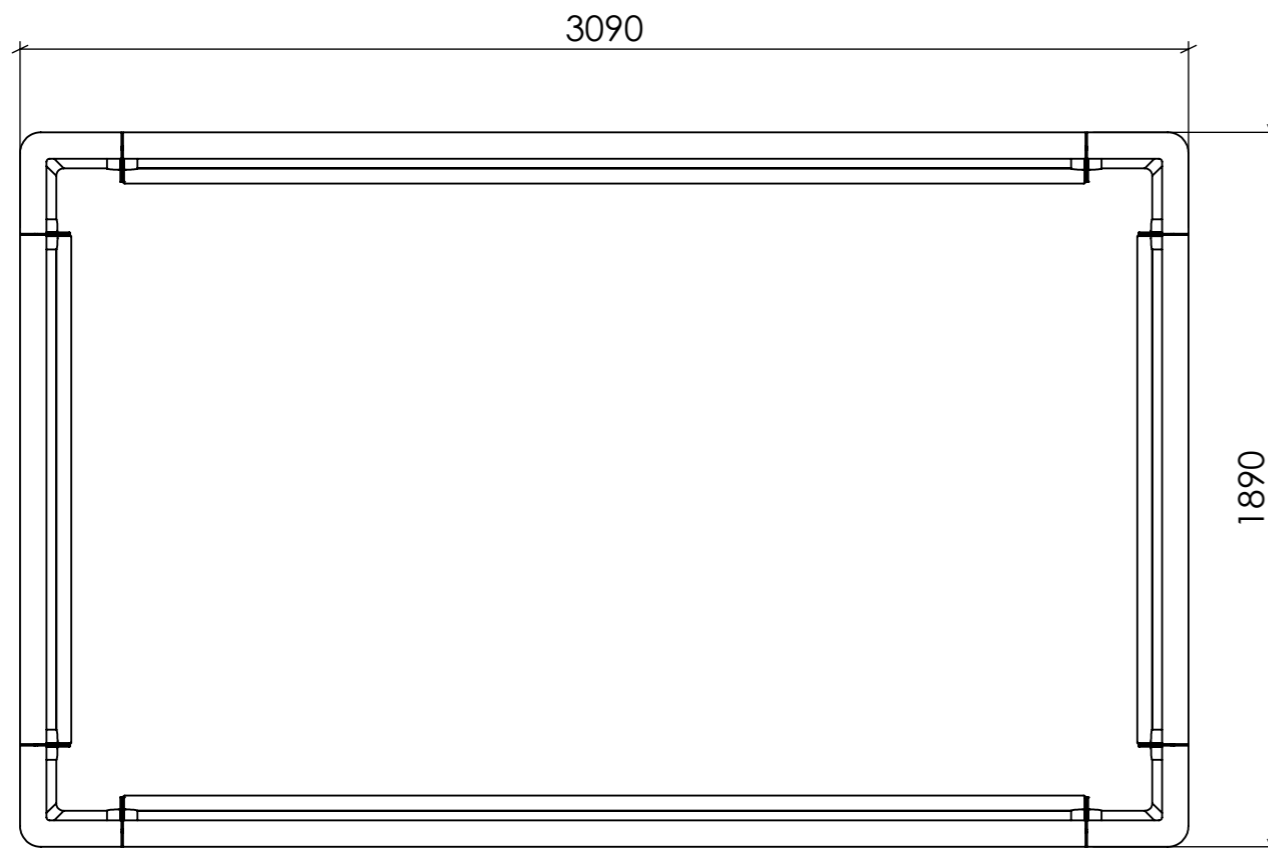

TOPPVY

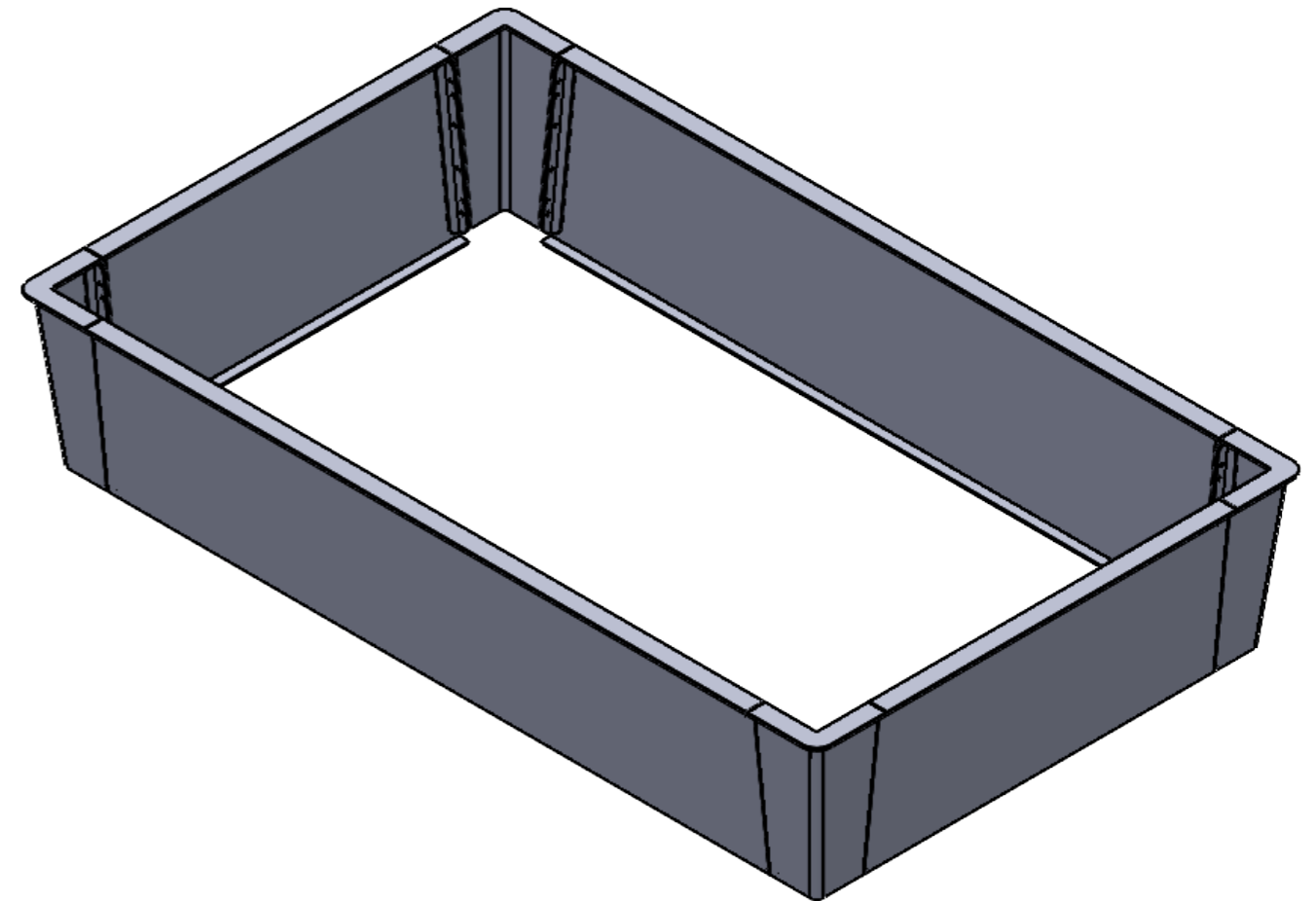

Svetsklass C	Förbehandlingsgrad P2	Toleransklass KLASS 1	Utförandeklass -	Certifiering SS-EN 1090-1	Övrigt	
Beräkningsunderlag -	Ritad Av DANIEL	Skapad Datum 2020-06-29	Godkänd Av PETER	Material -	Antal	Order- /Projektnummer
Ägare BLIDSBERGS MEKANISKA <small>Adress: Ulricehamnsvägen 27, 52376 Blidsberg Telefonnummer: 0321-31660 E-post: info@blidsbergs.se, www.blidsbergs.se</small>			Titel / Benämning HAGA Plantering - 1890x3090			
Artikel- / Ritningsnummer VFZ 452404 / VFZ+L 452406 / Corten 452408					Rev	Blad 1 (1)