

FRONTVY

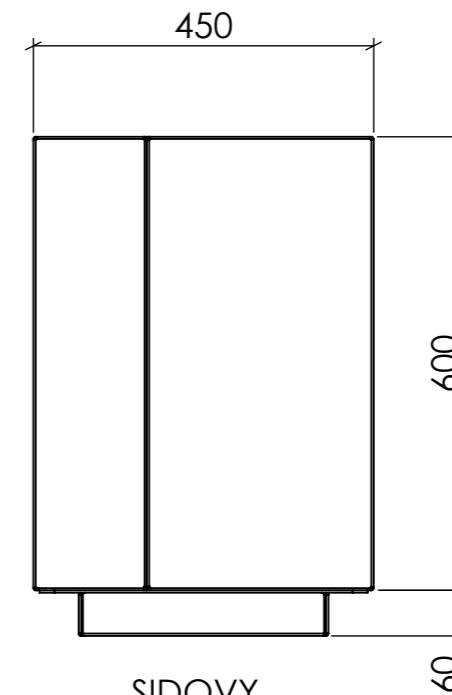

SIDOVY

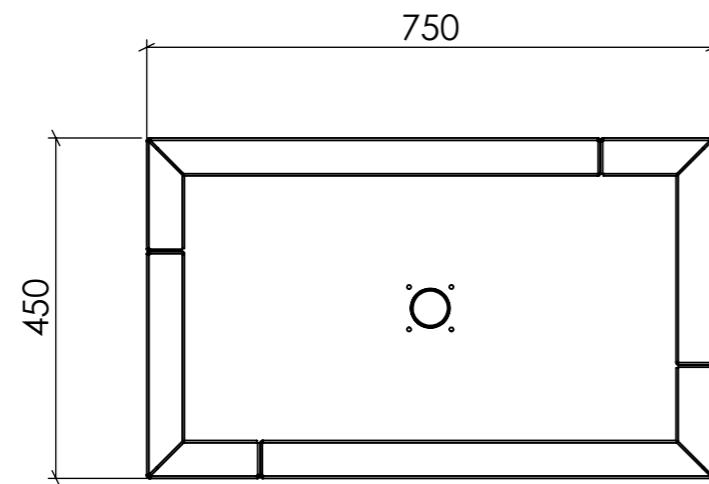

TOPPVY

Svetsklass C	Förbehandlingsgrad P2	Toleransklass KLASS 1	Utförandeklass -	Certifiering SS-EN 1090-1	Övrigt	
Beräkningsunderlag -	Ritad Av DANIEL	Skapad Datum 2020-06-02	Godkänd Av -	Material -	Antal	Order- /Projektnummer
Ägare  BLIDSBERGS MEKANISKA			Titel / Benämning FLORA Planteringskärl 450x750			
Adress: Ulricehamnsvägen 27, 52376 Blidsberg Telefonnummer: 0321-31660 E-post: info@blidsbergs.se, www.blidsbergs.se			Artikel- / Ritningsnummer VFZ 430206 / VFZ+P.LACK 430208 Cortenplåt 430212		Rev	Blad 1 (1)