

FRONTVY

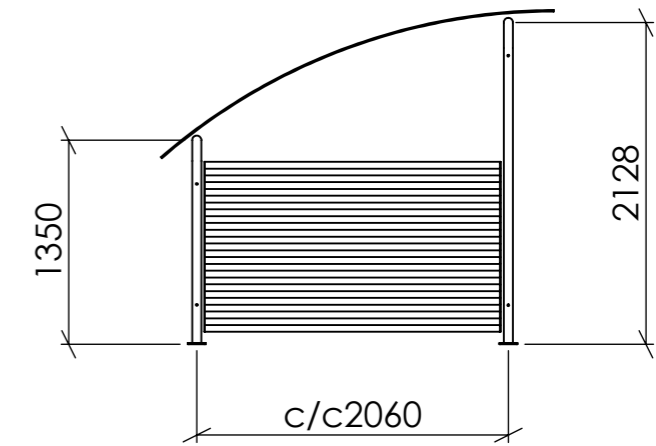

SIDOVY

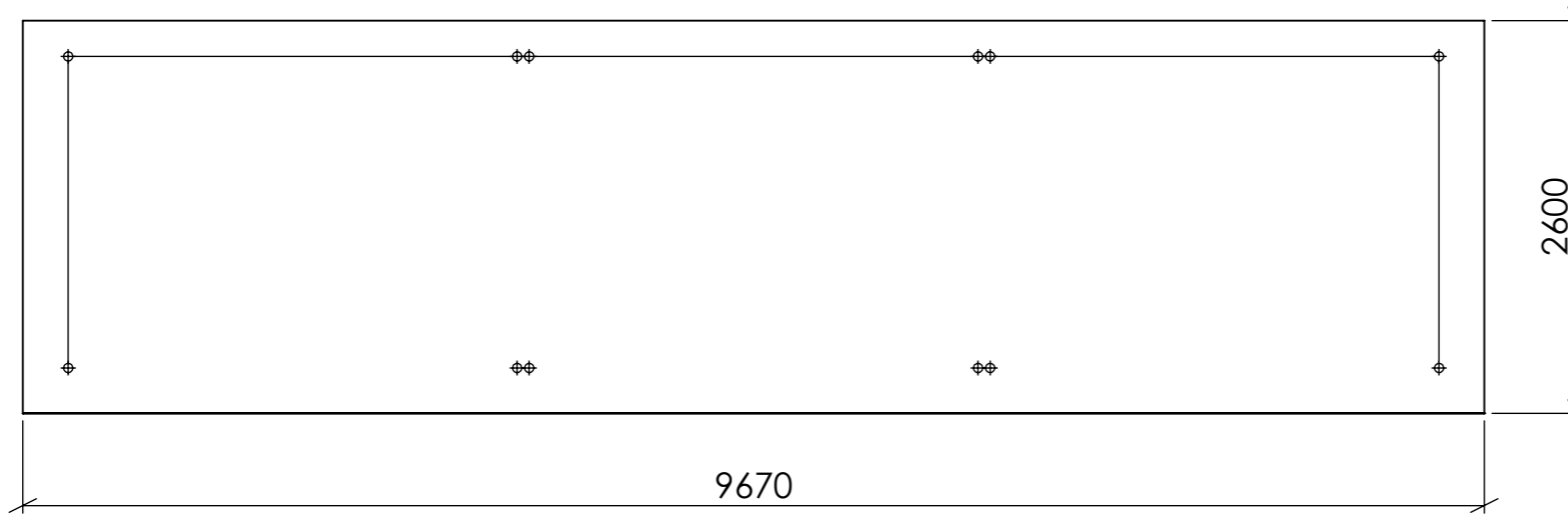

TOPPVY

Konstruerad Av	Ritad Av PETER	Skapad Datum 2011-06-17	Godkänd Av	Generell Tolerans	Skala	
Ägare	BLIDSBERGS MEKANISKA		Titel / Benämning BOGE 3 SEKTIONER TRÄSPALJÉ LÅG			
Adress: PL 2010, 52024 Blidsberg Telefonnummer: 0321-31660, Fax 0321 - 31512 E-post: info@blidsbergs.se, www.blidsbergs.se			Artikel Nr	Rev	Blad 1 (1)	