

FRONTVY

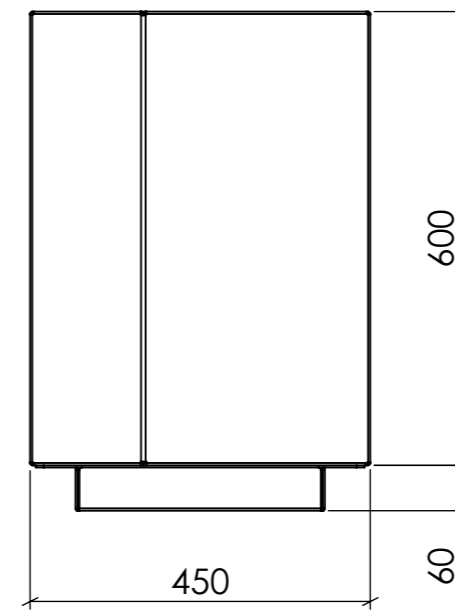

SIDOVY

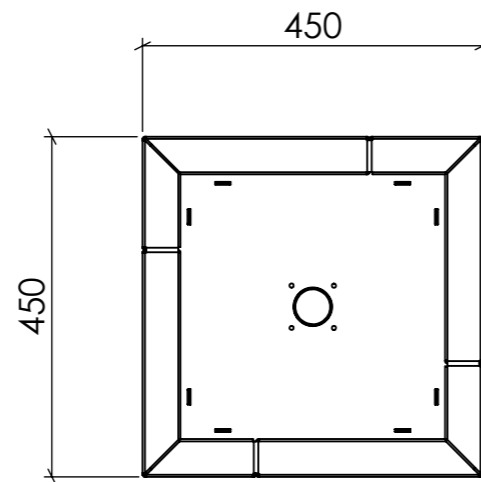

TOPPVY

Svetsklass <b>C</b>	Förbehandlingsgrad <b>P2</b>	Toleransklass <b>KLASS 1</b>	Utförandeklass <b>-</b>	Certifiering <b>SS-EN 1090-1</b>	Övrigt	
Beräkningsunderlag <b>-</b>	Ritad Av <b>DANIEL</b>	Skapad Datum <b>2020-04-15</b>	Godkänd Av <b>PETER</b>	Material <b>-</b>	Antal	Order- /Projektnummer
Ägare  <b>BLIDSBERGS MEKANISKA</b>			Titel / Benämning <b>PLANTERINGSKÄRL 450x450</b>			
Adress: Ulricehamnsvägen 27, 52376 Blidsberg Telefonnummer: 0321-31660 E-post: info@blidsbergs.se, www.blidsbergs.se			Artikel- / Ritningsnummer <b>VFZ 430101 / VFZ + P.LACK 430105 / CORTENPLÅT 430109</b>	Rev	Blad <b>1 (1)</b>	